

# Installation, Operation & Maintenance Manual

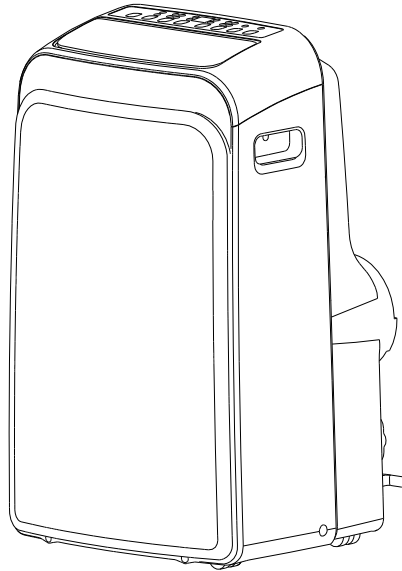

# Portable Room Air Conditioner and Heat Pump

PS-121B

PSH-141A

Thank you for purchasing our Portable Air Conditioner.  
Before using your air conditioner, please read this instruction  
manual carefully and keep it for future reference.

READ AND SAVE THESE INSTRUCTIONS!

*Comfort-Aire*<sup>®</sup>

## **Contents**

---

Preparation.....	2
Safety Precautions.....	3
Cautions.....	4
Installation.....	5
Operation.....	9
Maintenance.....	14
Faults Diagnosis.....	15
Design and Compliance Notes.....	16

## Preparation

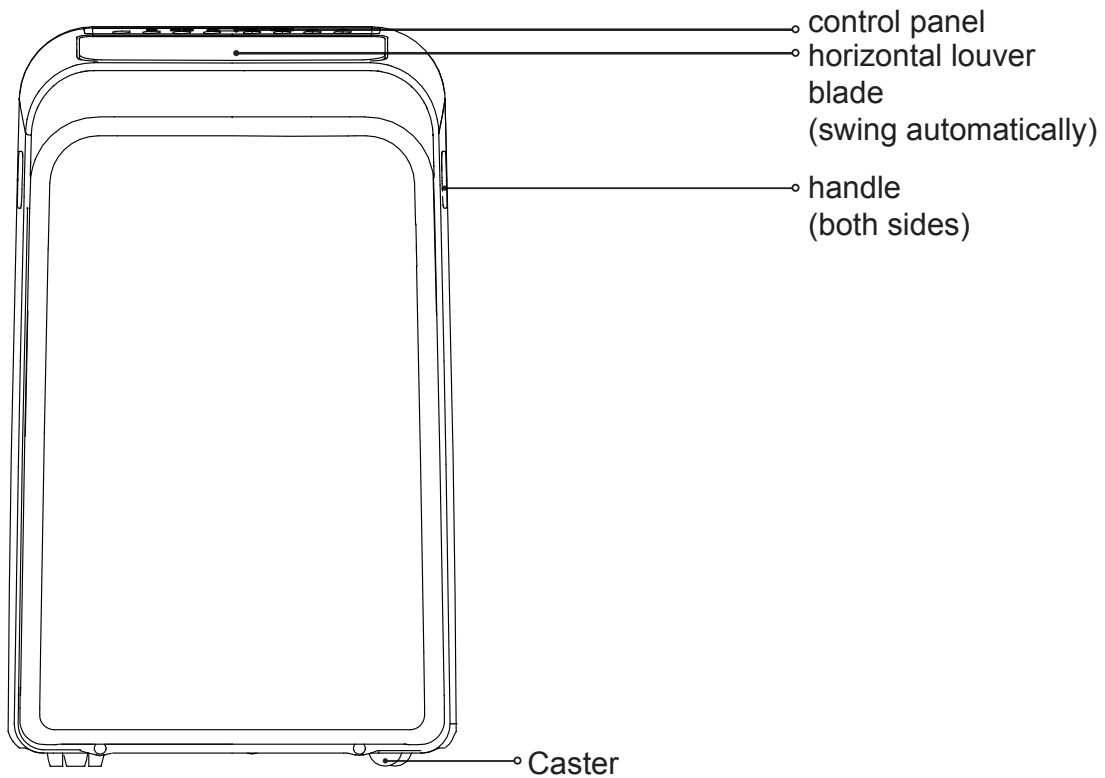

**front**

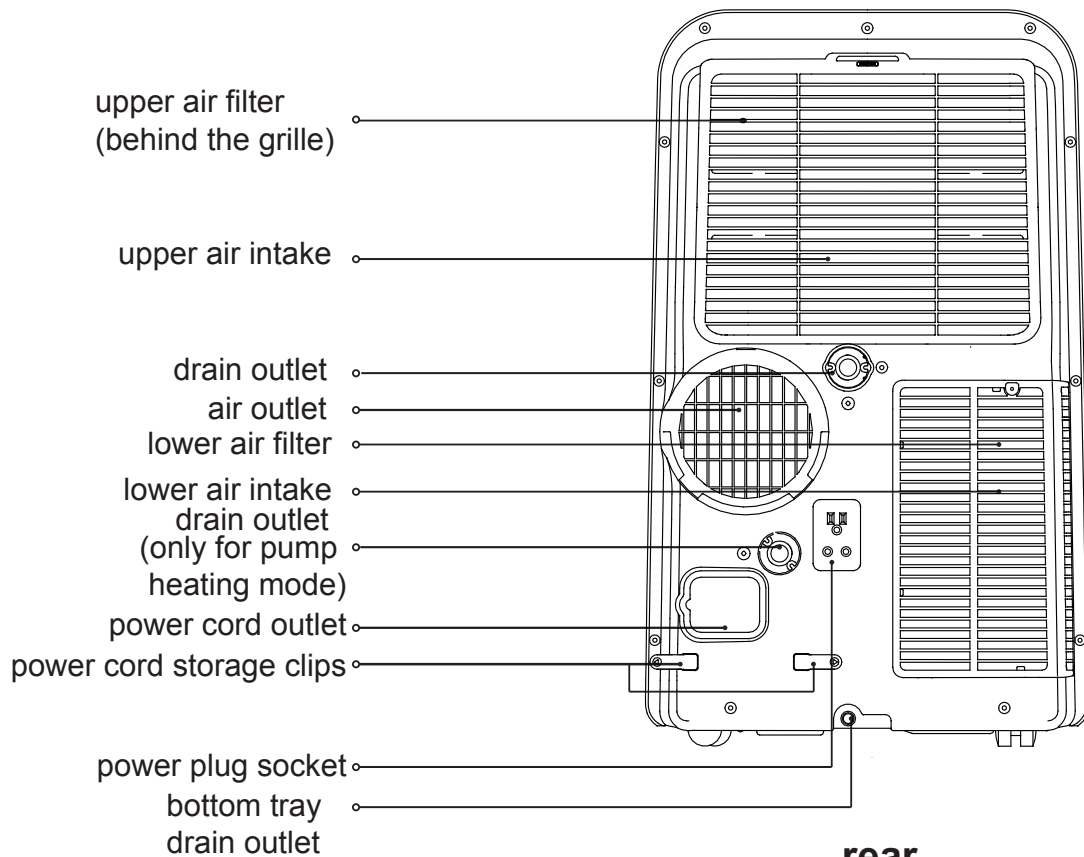

**rear**

## ***Safety Precautions***

---

**Please read through these instructions before you start the installation process. Improper installation can cause damage to the unit, your personal property, and also poses a personal safety hazard.**

- Installation must be performed according to the installation instructions. Improper installation can cause water leakage, electrical shock, or fire.
- Use only the included accessories and parts, and specified tools for the installation. Using non-standard parts can cause water leakage, electrical shock, fire, and injury or property damage.
- Make sure that the outlet you are using is grounded and has the appropriate voltage. The power cord is equipped with a three-prong grounding plug to protect against shock. Voltage information can be found on the side of the unit, behind the grille.
- Install the unit on a flat, sturdy surface. Failure to do so could result in damage or excessive noise and vibration.
- The unit must be kept free from obstructions to ensure proper function and to mitigate safety hazards.
- DO NOT modify the length of the power cord or use an extension cord to power the unit. DO NOT share a single outlet with other electrical appliances. Improper power supply can cause fire or electrical shock.
- DO NOT install your air conditioner in a wet room such as a bathroom or laundry room. Too much exposure to water can cause electrical components to short circuit.
- DO NOT install the unit in a location that may be exposed to combustible gas, as this could cause fire.
- The unit has wheels to facilitate moving. Make sure not to use the wheels on thick carpet or to roll over objects, as these could cause tipping.
- DO NOT operate a unit that has been dropped or damaged.
- Only use the included accessories and specified parts for installation. Using nonstandard parts can cause water leakage, electrical shock, fire, and injury or property damage.
- The unit must be kept free from obstruction to ensure proper function.
- DO NOT allow children to play with the air conditioner. Children must be supervised around the unit at all times.
- If the air conditioner is knocked over during use, turn off the unit and unplug it from the main power supply immediately. Visually inspect the unit to ensure there is no damage. If you suspect the unit has been damaged, contact a technician or customer service for assistance.
- In a thunderstorm, the power must be cut off to avoid damage to the machine due to lightning.

## ***Cautions***

---

- This appliance can be used by children aged from 8 years and above and person with reduced physical, sensory or mental capabilities or lack of experience and knowledge if they have been given supervision or instruction concerning use of the appliance in a safe way and understand the hazards involved. Children should not play with the appliance. Cleaning and user maintenance should not be made by children without supervision.
- This appliance is not intended for use by persons (including children) with reduced physical, sensory or mental capabilities or lack of experience and knowledge, unless they have been given supervision or instruction concerning use of the appliance by a person responsible for their safety.
- Children should be supervised to ensure that they do not play with the appliance.
- If the supply cord is damaged, it must be replaced by the manufacturer, its service agent or similarly qualified persons in order to avoid a hazard.
- Prior to cleaning or other maintenance, the appliance must be disconnected from the supply mains.
- Do not install the appliance in a location that may be exposed to combustible gas.
- If combustible gas accumulates around the unit, it may cause fire.
- Do not run cord under carpeting. Do not cover cord with throw rugs, runners, or similar coverings. Do not route cord under furniture or appliances. Arrange cord away from traffic area so it will not be tripping hazard.
- Do not operate unit with a damaged cord or plug. Discard unit or return to an authorized service facility for examination and/or repair.
- To reduce the risk of fire or electric shock, do not use this appliance with any solid-state speed control device.
- The appliance shall be installed in accordance with national wiring regulations.
- Contact the authorized service technician for repair or maintenance of this unit.
- Contact the authorized installer for installation of this unit.
- When there are wide differences between "USER'S MANUAL" and "Remote controller Illustration" on function description, the description on "USER' S MANUAL" shall prevail.
- Do not operate your air conditioner in a wet room such as a bathroom or laundry room.

## Installation

### Choosing The Right Location

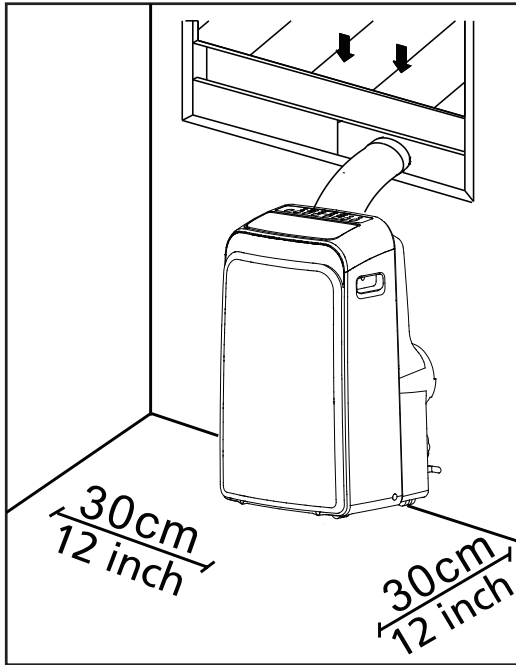

Your installation location should meet the following requirements:

- Make sure that you install your unit on an even surface to minimize noise and vibration.
- The unit must be installed near a grounded plug, and the Collection Tray Drain (found on the back of the unit) must be accessible.
- The unit should be located at least 30cm (12") from the nearest wall to ensure proper air conditioning.
- DO NOT cover the Intakes, Outlets or Remote Signal Receptor of the unit, as this could cause damage to the unit.



### Note About Fluorinated Gases

- This air-conditioning unit is a hermetically sealed unit that contains fluorinated gases. For specific information on the type of gas and the amount, please refer to the relevant label on the unit itself.
- Installation, service, maintenance and repair of this unit must be performed by a certified technician.
- Product un-installation and recycling must be performed by a certified technician.
- If the system has a leak-detection system installed, it must be checked for leaks at least every 12 months.
- When the unit is checked for leaks, proper record-keeping of all checks is strongly recommended.

#### NOTE:

All the illustrations in the manual are for explanation purpose only. Your machine may be slightly different. The actual shape shall prevail. The unit can be controlled by the unit control panel alone or with the remote controller. This manual does not include Remote Controller Operations, see the <<Remote Controller Instruction>> packed with the unit for details.











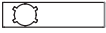

## Installation

### Tools Needed

- Medium Phillips screwdriver
- Tape measure or ruler
- Knife or scissors
- Saw (optional, to shorten window adaptor for narrow windows)

### Accessories

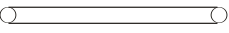
Your Window Installation Kit fits windows 67.5-123cm (26.5-48") and can be shortened for smaller windows.

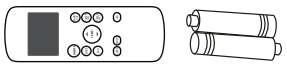
Part	Description	Quantity
	Unit Adaptor	1 pc
	Exhaust Hose	1 pc
	Window Slider Adaptor	1 pc
	Bolt	1 pc
	Window Slider A	1 pc
	Window Slider B	1 pc
	Foam Seal A (Adhesive)	2 pc
	Foam Seal B (Adhesive)	2 pc
	Foam Seal C (Non-adhesive)	1 pc
	Security Bracket and 2 Screws	1 set
	Drain Hose	1 pc
	Drain Hose Adaptor(only for heat pump mode)	1 pc
	Remote Controller and Battery (For remote control models only)	1 set

### Window Installation Kit Step One: Preparing the Exhaust Hose assembly

Press the exhaust hose into the window slider adaptor and unit adaptor, clamp automatically by elastic buckles of the adaptors.

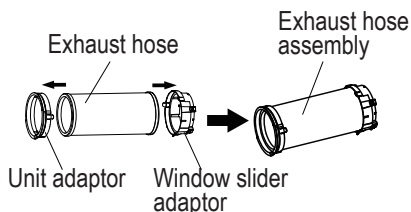

### Step Two: Install the Exhaust Hose assembly to the unit

Insert unit adaptor of the Exhaust hose assembly into the lower groove of the air outlet of the unit while the hook of the adaptor is aligned with the hole seat of the air outlet and slide down the Exhaust hose assembly along the arrow direction for installation.

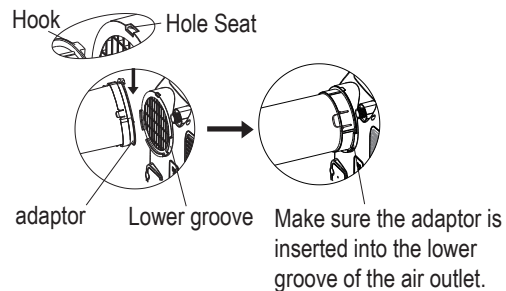

## Installation

### Step Three: Preparing the Adjustable Window Slider

1. Depending on the size of your window, adjust the size of the window slider.
2. If the length of the window requires two window sliders, use the bolt to fasten the window sliders once they are adjusted to the proper length.

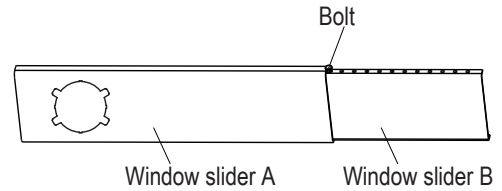

#### Note:

Once the Exhaust Hose assembly and Adjustable Window Slider are prepared, choose from one of the following two installation methods.

### Type 1: Hung Window Installation

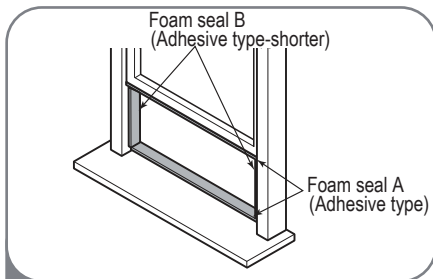

- 1 Cut the adhesive foam seal A and B strips to the proper lengths, and attach them to the window sash and frame as shown.

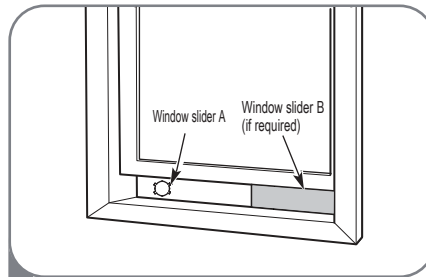

- 2 Insert the window slider assembly into the window opening.

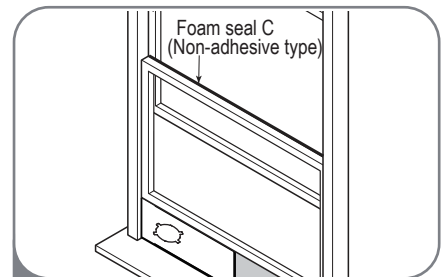

- 3 Cut the non-adhesive foam seal C strip to match the width of the window. Insert the seal between the glass and the window frame to prevent air and insects from getting into the room.

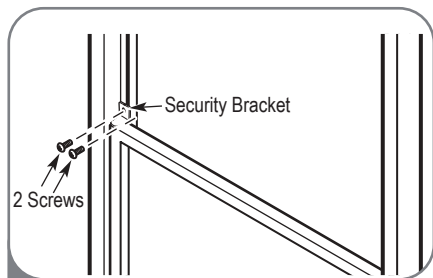

- 4 If desired, install the security bracket with two screws as shown.

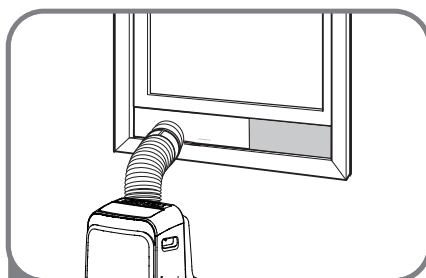

- 5 Insert the window slider adaptor into the hole of the window slider.



## Installation

### Type 2: Sliding Window Installation

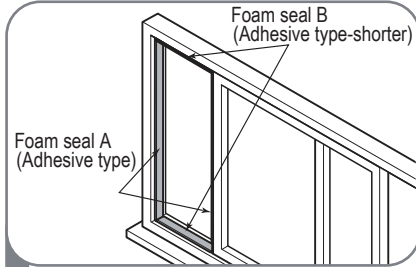

1 Cut the adhesive foam seal A and B strips to the proper lengths, and attach them to the window sash and frame as shown.

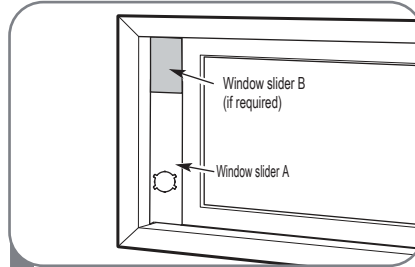

2 Insert the window slider assembly into the window opening.

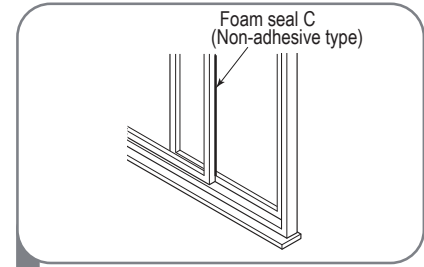

3 Cut the non-adhesive foam seal C strip to match the window height. Insert the foam seal between the glass and the window frame to prevent air and insects from getting into the room.

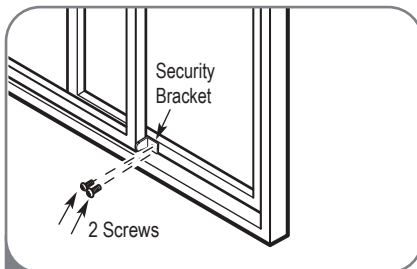

4 If desired, install the security bracket with two screws as shown.

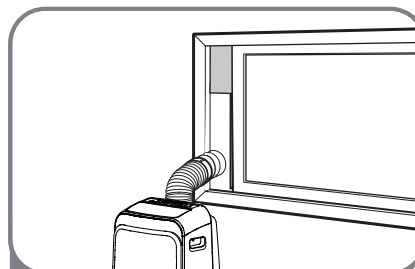

5 Insert the window slider adaptor into the hole of the window slider.

#### Note:

To ensure proper function, **DO NOT** over-extend or bend the hose. Make sure that there is no obstacle around the air outlet of the exhaust hose (in the range of 500mm) in order for the exhaust system to work properly. All illustrations in this manual are for explanation purposes only. Your air conditioner may be slightly different. The actual shape shall prevail.



## Operation

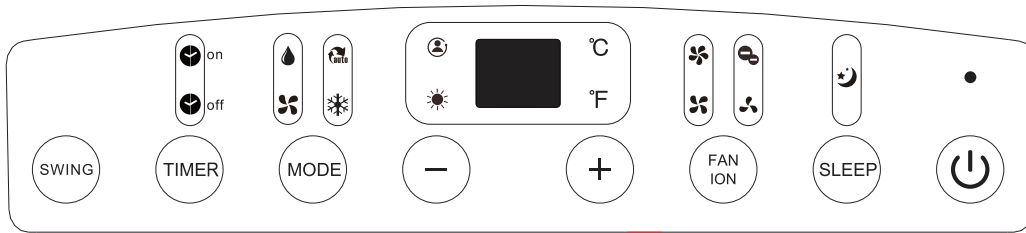

### Swing button

Used to initiate the Auto swing feature. When the operation is ON, pressing the SWING button can stop the louver at the desired angle.

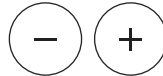

### Up (+) and Down (-) buttons

Used to adjust (increasing/decreasing) temperature settings in 1°C/1°F increments in a range of 17°C/62°F to 30°C/86°F or the TIMER setting in a range of 0~24hrs.



### Timer button

Used to initiate the AUTO ON start time and AUTO OFF stop time program, in conjunction with the + & - buttons. The timer on/off indicator light illuminates under the timer on/off settings

**NOTE: The control is capable of displaying temperature in degrees Fahrenheit or degrees Celsius. To convert from one to the other, press and hold the Up and Down buttons at the same time for 3 seconds.**



### Mode button

Selects the appropriate operating mode. Each time you press the button, a mode is selected in a sequence that goes from AUTO, COOL, DRY, FAN and HEAT (cooling only models without). The mode indicator light illuminates under the different mode settings.



### Fan/Ion button (Ion is optional)

Controls the fan speed. Press to select the fan speed in four steps-LOW, MID, HIGH and AUTO. The fan speed indicator light illuminates under different fan settings. NOTE: Press this button for 3 seconds to initiate ION feature. The ion generator is energized and will help to remove pollen and impurities from the air, and trap them in the filter. Press it for 3 seconds again to stop the ION feature.



### Sleep/Eco button

Used to initiate the SLEEP/ECO operation.



### Power button

Power switch on/off.

## Operation



### LED display

Shows the set temperature in °C or °F and the Auto-timer settings. While on DRY and FAN modes, it shows the room temperature. Shows Error codes and protection code:

E1-Room temperature sensor error.

E2-Evaporator temperature sensor error.

E3-Condenser temperature sensor error (on some models).

E4-Display panel communication error.



P1-Bottom tray is full--Connect the drain hose and drain the collected water away. If protection repeats, call for service.

**Note: When one of the above malfunctions occurs, turn off the unit and check for any obstructions. Restart the unit, if the malfunction is still present, turn off the unit and unplug the power cord. Contact the manufacturer, service agents, or a similarly qualified person for service.**

## Operation Instructions

### COOL operations

- Press the "MODE" button until the "COOL" indicator light comes on.
- Press the ADJUST buttons "+" or "-" to select your desired room temperature. The temperature can be set within a range of 17°C~30°C/62°F~86°F.
- Press the "FAN SPEED" button to choose the fan speed.

### HEAT operation (cooling only models without)

- Press the "MODE" button until the "HEAT" indicator light comes on.
- Press the ADJUST buttons "+" or "-" to select your desired room temperature. The temperature can be set within a range of 17°C~30°C/62°F~86°F.
- Press the "FAN SPEED" button to choose the fan speed. For some models, the fan speed cannot be adjusted under HEAT mode.

### DRY operation

- Press the "MODE" button until the "DRY" indicator light comes on.
- Under this mode, you cannot select a fan speed or adjust the temperature. The fan motor operates at LOW speed.
- Keep windows and doors closed for the best dehumidifying effect.

## Operation

---

### AUTO operation

- When you set the air conditioner in AUTO mode, it will automatically select cooling, heating (cooling only models without), or fan only operation depending on what temperature you have selected and the room temperature.
- The air conditioner will control room temperature automatically around the temperature point set by you.
- Under AUTO mode, you cannot select the fan speed.

### FAN operation

- Press the "MODE" button until the "FAN" indicator light comes on.
- Press the "FAN SPEED" button to choose the fan speed. The temperature cannot be adjusted.

### TIMER operation

- When the unit is on, pressing the Timer button will initiate the Auto-off stop program, the TIMER OFF indicator light illuminates. Press the UP or DOWN button to select the desired time. Press the TIMER button again within five seconds, the Auto-on start program is initiated, and the TIMER ON indicator light illuminates. Press the up or down button to select the desired Auto-on start time.
- When the unit is off, press the Timer button to initiate the Auto-on start program, press it again within five seconds to initiate the Auto-off stop program.
- Press or hold the UP or DOWN button to change the Auto time by 0.5 hour increments, up to 10 hours, then in one hour increments up to 24 hours. The control will count down the time remaining until start.
- The system will automatically revert back to display the previous temperature setting if there is no operation in a five second period.
- Turning the unit ON or OFF at any time or adjusting the timer setting to 0.0 will cancel the Auto Start/Stop timer program.
- When the malfunction occurs, the Auto Start/Stop timed program will also be canceled.

### SLEEP/ECO operation

- Press this button and the selected temperature will increase (cooling) or decrease (heating) by 1°C/1°F 30 minutes. The temperature will then increase (cooling) or decrease (heating) by another 1°C/1°F after an additional 30 minutes. This new temperature will be maintained for seven hours before it returns to the originally selected temperature. This ends the Sleep/Eco mode and the unit will continue to operate as originally programmed.

**NOTE: This feature is unavailable under FAN or DRY mode.**

## Operation

### Other features

#### FOLLOW ME/TEMP SENSING feature (optional)

**NOTE:** This feature can be activated from the remote control **ONLY**. The remote control serves as a remote thermostat allowing for the precise temperature control at its location. To activate the Follow Me/Temp Sensing feature, point the remote control toward the unit and press the Follow Me/Temp Sensing button. The remote display is the actual temperature at its location. The remote control will send this signal to the air conditioner every three minutes until you press the Follow Me/Temp Sensing button again. If the unit does not receive the Follow Me/Temp Sensing signal during any seven minute interval, the unit will beep to indicate the Follow Me/Temp Sensing mode has ended.

#### AUTO-RESTART

If the unit breaks off unexpectedly due to loss of power, it will restart with the previous function setting automatically when the power resumes.

#### WAIT THREE MINUTES BEFORE RESUMING OPERATION

After the unit has stopped, it cannot be restarted for three minutes. This is to protect the unit. Operation will automatically start after three minutes.

#### AIR FLOW DIRECTION ADJUSTMENT

The louver can be adjusted automatically. Adjust the air flow direction automatically (NOTE: On some models the louver can be adjusted manually only):

- When the Power is ON, the louver opens fully.
- Press the SWING button on the panel or remote controller to initiate the Auto swing feature. The louver will swing up and down automatically.
- Please do not adjust the louver manual

#### Water drainage

- During dehumidifying modes, remove the upper drain plug from the back of the unit, install the drain connector (5/8" universal female hose connections) with 3/4" hose (locally purchased). For the models without drain a connector, attach the drain hose to the hole. Place the open end of the hose directly over the drain area in your basement floor.

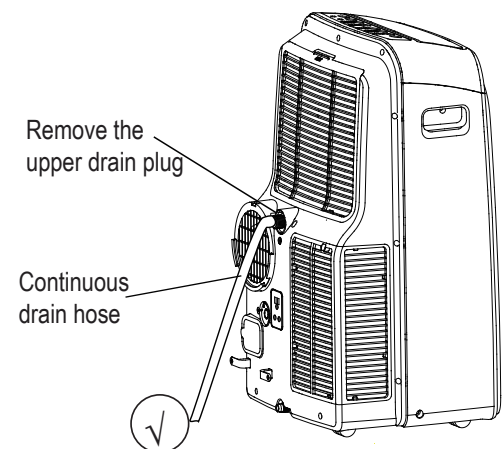

## Operation

- During heat pump mode, remove the lower drain plug from the back of the unit, install the drain connector (5/8" universal female hose connection) with 3/4" hose (locally purchased). For the models without a drain connector, attach the drain hose to the hole. Place the open end of the Hose adapter directly over the drain area in your basement floor.

**NOTE: Make sure the hose is secure so there are no leaks. Direct the hose toward the drain, making sure that there are no kinks that will stop the water flowing. Place the end of the hose into the drain and make sure the end of the hose is down to let the water flow smoothly.**

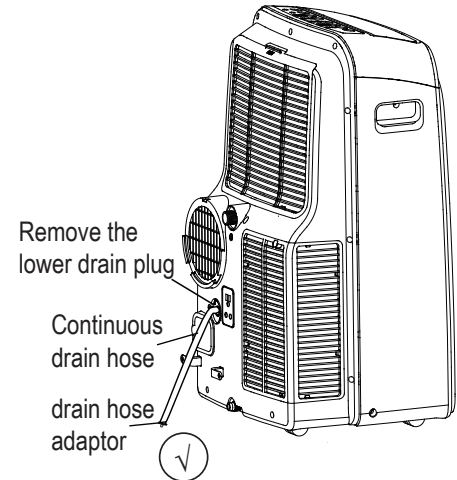

(See Figs with (✓)). Do not allow traps or rise. (See Figs with (X)).  
 When the continuous drain hose is not used, ensure that the corresponding drain plug and knob are installed firmly to prevent leakage.

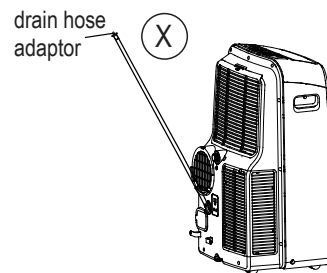
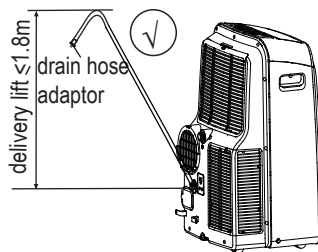

- When the water level of the bottom tray reaches a predetermined level, the unit beeps 8 times, the digital display area shows "P1". At this time the air conditioning/dehumidification process will immediately stop. However, the fan motor will continue to operate (this is normal). Carefully move the unit to a drain location, remove the bottom drain plug and let the water drain away. Reinstall the bottom drain plug and restart the machine until the "P1" symbol disappears. If the error repeats, call for service.

**NOTE: Be sure to reinstall the bottom drain plug firmly to prevent leakage before using the unit.**

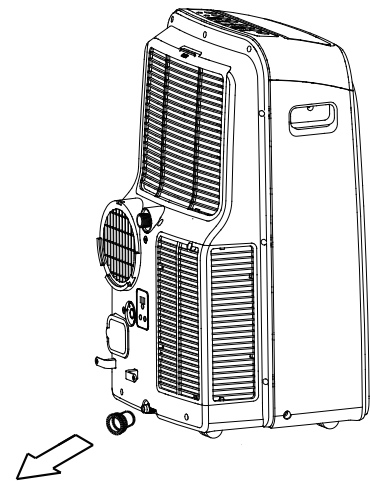

## Maintenance

### Safety Precautions

- Always unplug the unit before cleaning or servicing.
- DO NOT use flammable liquids or chemicals to clean the unit.
- DO NOT wash the unit under running water. Doing so causes electrical danger.
- DO NOT operate the machine if the power supply was damaged during cleaning. A damaged power cord must be replaced with a new cord from the manufacturer.

### Clean the Air Filter

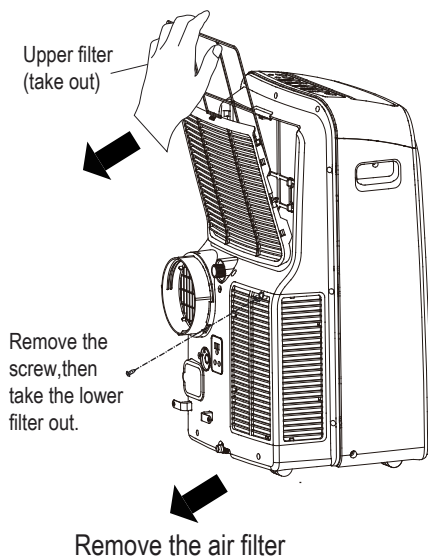

### Maintenance Tips

- Be sure to clean the air filter every two weeks for optimal performance.
- The water collection tray should be drained immediately after P1 error occurs, and before storage to prevent mold.
- In households with animals, you will have to periodically wipe down the grill to prevent blocked airflow due to animal hair.

### Clean the Unit

Clean the unit using a damp, lint-free cloth and mild detergent. Dry the unit with a dry, lint-free cloth.

### Store the unit when not in use

- Drain the unit's water collection tray according to the instructions in the following section.
- Run the appliance on FAN mode for 12 hours in a warm room to dry it and prevent mold.
- Turn off the appliance and unplug it.
- Clean the air filter according to the instructions in the previous section. Reinstall the clean, dry filter before storing.
- Remove the batteries from the remote control.



Be sure to store the unit in a cool, dark place. Exposure to direct sunshine or extreme heat can shorten the lifespan of the unit.

## Faults Diagnosis

**Please refer to the following form before requesting service:**

Problem	Possible Cause	Troubleshooting
Unit does not turn on when pressing ON/OFF button	P1 Error Code	The Water Collection Tray is full. Turn off the unit, drain the water from the Water Collection Tray and restart the unit.
	In COOL mode: room temperature is lower than the set temperature	Reset the temperature
Unit does not cool well	The air filter is blocked with dust or animal hair	Turn off the unit and clean the filter according to instructions
	Exhaust hose is not connected or is blocked	Turn off the unit, disconnect the hose, check for blockage and reconnect the hose
	The unit is low on refrigerant	Call a service technician to inspect the unit and top off refrigerant
	Temperature setting is too high	Decrease the set temperature
	The windows and doors in the room are open	Make sure all windows and doors are closed
	The room area is too large	Double-check the cooling area
	There are heat sources inside the room	Remove the heat sources if possible
The unit is noisy and vibrates too much	The ground is not level	Place the unit on a flat, level surface
	The air filter is blocked with dust or animal hair	Turn off the unit and clean the filter according to instructions
The unit makes a gurgling sound	This sound is caused by the flow of refrigerant inside the unit	This is normal



## Design and Compliance Notes

---

### Design Notice

In order to ensure the optimal performance of our products, the design specifications of the unit and remote control are subject to change without prior notice.

### Energy Rating Information

The Energy Rating for this unit is based on an installation using an un-extended exhaust duct without adapters A or B (as shown in the Installation section of this manual).

### Unit Temperature Range

Mode	Temperature Range
Cool	17-35°C (62-95°F)
Dry	13-35°C (55-95°F)
Heat (pump heat mode)	5-30°C (41-86°F)
Heat (electrical heat mode)	≤ 30°C (86°F)



## LIMITED EXPRESS WARRANTY

All MARS products are designed for long life and reliable service to help keep your home comfortable. We're so confident in the design, quality components and construction that we back your unit with a strong warranty coverage as described in this document.

To be eligible for the full term of this Limited Express Warranty, complete and mail the card below or register your purchase online at [www.marsdelivers.com](http://www.marsdelivers.com) as soon as possible. Registration must occur within 90 days of the purchase to qualify for the full term of the coverage.

Don't forget to read your owner's manual and ask your installer about regular maintenance procedures that will help keep your unit operating at peak efficiency.

### LIMITED ONE (1) YEAR PARTS AND LABOR EXPRESS WARRANTY

MARS warrants all parts of the Portable Room Air Conditioner to be free from defects in workmanship and materials for normal use and maintenance for one (1) year from the date of purchase by the original consumer. This Express Limited Warranty applies only when the Portable Room Air Conditioner is installed and operated per MARS installation and operating instructions for normal use.

### LIMITED FIVE (5) YEAR SEALED SYSTEM WARRANTY

The sealed system only (consisting of compressor, evaporator, condenser and interconnected tubing) is warranted to be free from defects in workmanship and materials for normal use and maintenance for four additional years, for a total of five (5) years from the date of purchase by the original consumer. This five year warranty applies only when the system is installed and operated per MARS, installation and operation instructions for normal use.

### EXCEPTIONS

The Limited Express Warranty does not cover normal maintenance—MARS recommends that regular inspection/maintenance be performed at least once a season and proof of maintenance be kept. Additionally, labor charges (except as described in paragraph 1 above), diagnostic charges, transportation charges for replacement parts, replacement of refrigerant or filters, any other service calls/repairs are not covered by this Limited Warranty. It also does not cover any portion or component of the system that is not supplied by MARS, regardless of the cause of failure of such portion or component.

### CONDITIONS FOR WARRANTY COVERAGE

- Unit must be operated according to MARS operating instructions included with the unit and cannot have been subjected to accident, alteration, improper repair, neglect or misuse, or an act of God (such as a flood)
- Installation must be according to MARS installation instructions
- Serial numbers and/or rating plate have not been altered or removed
- Unit is not operated in a corrosive environment
- Performance cannot be impaired by use of any product not authorized by MARS, or by any adjustments or adaptations to components
- Damage has not been a result of inadequate wiring or voltage conditions, use during brown-out conditions, or circuit interruptions
- Air flow around any section of the unit has not been restricted
- Unit is not put to commercial, business, rental or other use or application other than for residential use

Please visit [www.marsdelivers.com](http://www.marsdelivers.com) to register your new product



### DURATION OF WARRANTY & REGISTRATION

The warranty begins on the date of purchase by the original consumer. The consumer must complete and return the warranty registration card or register at [www.marsdelivers.com](http://www.marsdelivers.com) within 90 days of purchase. The consumer must retain a receipted bill of sale as proof of warranty period. Without this proof, the express warranty begins on the date of shipment from the factory.

### REMEDY PROVIDED BY THE LIMITED EXPRESS WARRANTY

The sole remedy under the Limited Warranty is replacement of the defective part. If replacement parts are required within the period of this warranty, MARS, replacement parts shall be used; any warranty on the replacement part(s) shall not affect the applicable original unit warranty. Except during the first year, labor to diagnose and replace the defective part is not covered by this Limited Express Warranty. If for any reason the replacement part/product is no longer available during the warranty period, MARS shall have the right to allow a credit in the amount of the current suggested retail price of the part/product instead of providing repair or replacement.

### LIMITATION OF LIABILITY

1. There are no other express or implied warranties. MARS makes no warranty of merchantability. We do not warrant that the unit is suitable for any particular purpose or can be used in buildings or rooms of any particular size or condition except as specifically provided in this document. There are no other warranties, express or implied, which extend beyond the description in this document.
2. All warranties implied by law are limited in duration to the one-year term of the Parts Warranty. Your exclusive remedy is limited to the replacement of defective parts. **We will not be liable for any consequential or incidental damages caused by any defect in this unit.**
3. This warranty gives you specific legal rights and you may also have other rights which vary from state to state. Some states do not allow limitation on how long an implied warranty lasts or do not allow the exclusion or limitation of incidental or consequential damages, so the above limitations or exclusions may not apply to you.
4. No warranties are made for units sold outside the continental United States and Canada. Your distributor or final seller may provide a warranty on units sold outside these areas.
5. MARS will not be liable for damages if our performance regarding warranty resolution is delayed by events beyond our control including accident, alteration, abuse, war, government restrictions, strikes, fire, flood, or other acts of God.

### HOW TO OBTAIN WARRANTY SERVICE OR PARTS

If you have a warranty claim, contact our North American service provider at 1-866-557-1865. Have the model number, serial number, and date of purchase available for this call. Do not return your unit to the store where it was purchased.

Owner responsibilities are set forth in the instruction manual—read it carefully.

### KEEP THIS INFORMATION AS A RECORD OF YOUR PURCHASE

#### PORTABLE AIR CONDITIONER

Model Number _____	Where Purchased _____
Serial Number _____	Store Location _____
Date of Purchase _____	Date of Installation _____

Remember to retain your bill of sale as proof of warranty period.

**THIS PAGE INTENTIONALLY LEFT BLANK**

---

Due to ongoing product improvements, specifications and dimensions are subject to change and correction without notice or incurring obligations. Determining the application and suitability for use of any product is the responsibility of the installer. Additionally, the installer is responsible for verifying dimensional data on the actual product prior to beginning any installation preparations.

Incentive and rebate programs have precise requirements as to product performance and certification. All products meet applicable regulations in effect on date of manufacture; however, certifications are not necessarily granted for the life of a product. Therefore, it is the responsibility of the applicant to determine whether a specific model qualifies for these incentive/rebate programs.



**1900 Wellworth Ave. • Jackson, MI 49203 • 517.787.2100 • [www.marsdelivers.com](http://www.marsdelivers.com)**